

4.3-inch Color LCD  
Remote Display

## KRD-10



Screen image: Wind Direction

System capable of displaying wide range of NMEA Information.  
GPS Compass, Weather Station, Wind Anemometer, Rudder and much more.

### Features

- ▶ Quick access Numeric Panel
- ▶ Up to 4 ports available with connecting optional junction box
- ▶ 19 display modes available to choose from
- ▶ Switchable between day mode and night mode

< Screen Image >

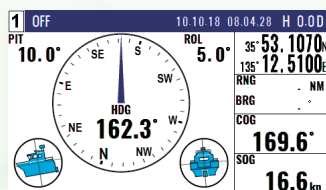

Compass

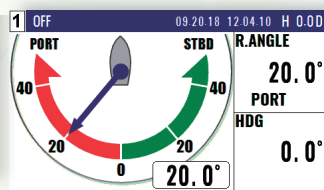

Rudder Angle

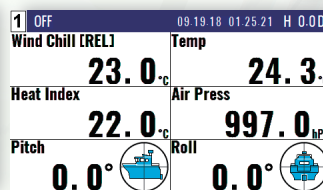

Weather Info

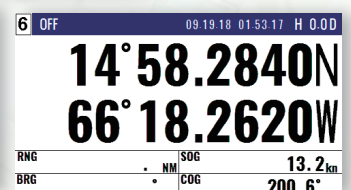

Navigation

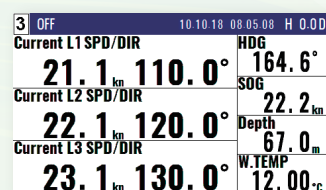

Current

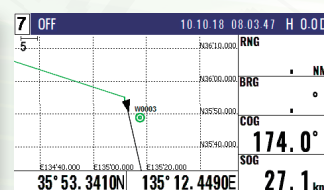

Plotter

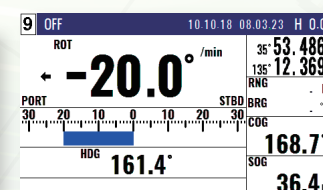

ROT

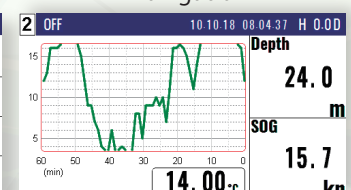

Water Temperature

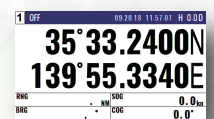

Day mode

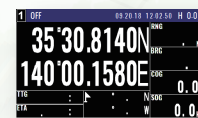

Night mode



## SPECIFICATIONS

Model	KRD-10	
Display size and type	4.3inch color LCD	
Display resolution	480 x 272 (WQVGA)	
Presentation modes	Navigation, Navigation graph, Highway, Plotter, Compass, ROT, Wind direction / Wind speed, Water temperature, Rudder angle, Distance info, General, Tide current, Weather info, Rain gauge, Custom	
Track display	Display range	0.025, 0.05, 0.1, 0.2, 0.5, 1, 2, 5, 10, 20 NM (sm, km)
	Usable ground	Within 80° in latitude
	Plotting interval	5, 10, 20, 30 seconds, 1 minutes, 0.01, 0.05, 0.1, 0.5, 1 NM (sm, km)
Plotting capacity	3,000 points	
Position data display	Latitude / Longitude in increments of 0.0001 minutes, Converted Loran C LOPs, Converted Loran A LOPs, Converted Decca LOPs	
Data display	Speed, Course, Heading, Distance / Bearing to waypoint, Cross track error, Time to go to waypoint, Total time to go and distance on route, DOP value, Present time (UTC or LTC), Navigation1, Navigation2, Navigation3, Steering, Highway, Plotter, Compass1, Compass2, ROT INFO, Rudder Angle, Distance info, Wind Direction analog, Water Temperature Graph, General1, General2, Tide Current, Weather Info, Rain Gauge, Lat / Lon, COG, SOG / STW, Rudder sensor Angle, TRIP / ODO, Current L1 SPD / DIR, Current L2 SPD / DIR, Current L3 SPD / DIR, Wind DIR / SPD, Wind Chill (REL), Wind Chill (TRUE), Heat Index, Air Pressure, Heave, Pitch, Roll, Rain Accumulation, Rain Duration, Rain Intensity Rate, Peak Rain Intensity Rate, Temperature, Humidity, Dew Point, Wind Direction (REL / TRUE), Wind Speed (REL / TRUE), Satellite status, Distance / Bearing between two points, POB display	
Instant (event) memory	1,000 points	
Waypoint memory	10,000 points (9,000 + Event 1,000)	
Route memory	100 routes reverse trail possible	
Alarms	GNSS Fix, Proximity, Cross track error, CDI, Anchor watch, Water temperature, Depth	
Position compensation	Latitude / Longitude, LOPs	
Magnetic compensation	Auto or Manual	
Parameters	Position (L / L, LOP), Language, LOP (Loran C, Loran A, Decca), Memory of waypoints and name (up to 10 letters), Selection of measuring unit (NM-kn, km-km/h, sm-mph), Temperature unit (°C, °F), Depth unit (m, fm, Lfm, ft, J.fm), Wind speed unit (kn, m/s, mph), Sailing mode (Great Circle, Rhumb Line) SOG / COG / Heading / Rotation averaging (smooth) factor.	
Input data format and sentences	NMEA 0183 Ver. 2.0 / 3.0 (DBT: Ver.1.5) CUR, DBT, DPT, GGA, GLL, GNS, GSA, GSV, HEV, HDG, HDT, HDM, HPR, MDA, MSS, MTW, MWD, MWV, RMA, RMB, RMC, ROT, RSA, VBW, VDR, VHW, VLW, VTG, XDR, ZDA	
Output data format and sentences	NMEA0183 Ver. 2.0 / 3.0 AAM, APB, BOD, BWC, DCN, DPT, DTM, GGA, GLC, GLL, GSA, GSV, HEV, HDT, HDM, HPR, MSS, MTW, MWV, RMB, RMC, ROT, RTE, VHW, VTG, WPL, XTE, ZDA	
NMEA ports	Total 2 : input / output *	
Power supply	10.8 to 31.2 V DC	
Power consumption	4.5 W or less	

\*Total 4: input / output with optional Junction box  
Note: Accuracy is subject to change in accordance with DoD civil GNSS user policy.

## Environmental

Operating temperature	-15 °C to +55°C
Water protection	IPX4

## CONNECTIONS

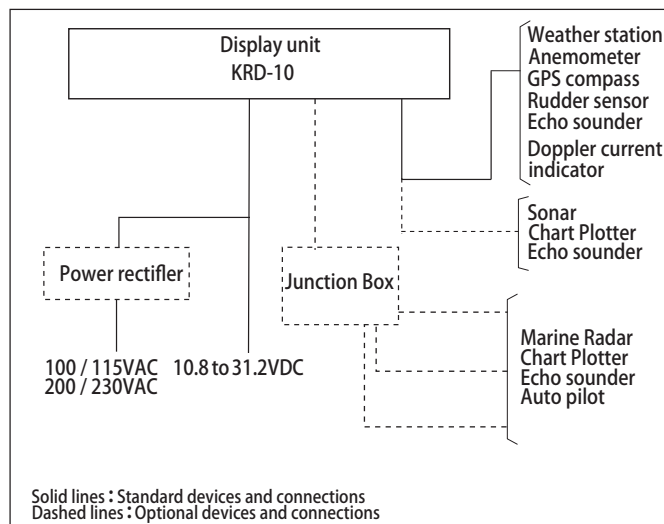

## EQUIPMENT LIST

### Standard Equipment

Display unit	KRD-10.MU	With mounting bracket, hard cover and BNC connector cap
DC power cable	CW-276-2M	With 5-pin connector and one end plain
Connecting cable	CW-376-1.5M	6 pin water resistant connector and one end plain (with ferrite core)
Operation Manual, Installation material		

### Option

Connecting cable, Junction box, Power rectifier, AC power cable

## DIMENSIONS AND WEIGHT

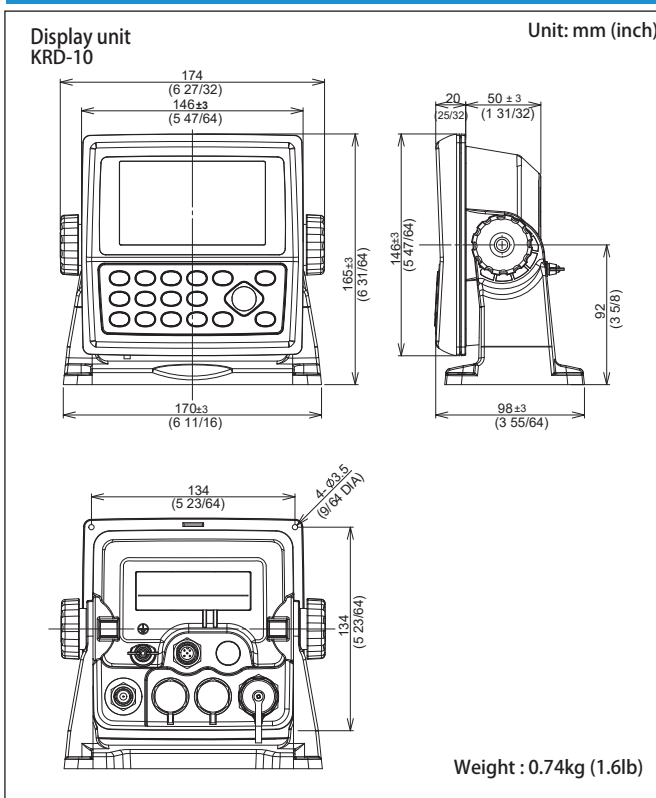

• Design and specifications are subject to change without notice.

**KODEN** Kodan Electronics Co., Ltd.

Tamagawa Office:  
2-13-24 Tamagawa, Ota-ku, Tokyo, 146-0095 Japan  
Tel: +81-3-3756-6501 Fax: +81-3-3756-6509  
Uenohara Office:  
5278 Uenohara, Uenohara-shi, Yamanashi, 409-0112 Japan  
Tel: +81-554-20-5860 Fax: +81-554-20-5875

overseas@koden-electronics.co.jp

[www.koden-electronics.co.jp](http://www.koden-electronics.co.jp)



**Safety precaution**

To ensure proper and safe use of the equipment, please carefully read and follow the instructions in the Operation Manual.

For details, please contact: